



DIGITAL RV

digital products & services for the mobile market

Installation - Servicing - Problem Solving



Catalogue

All pricing valid while stocks last and subject to change.



victron energy
BLUE POWER

TechniSat
MEGASAT
Brillantes Fernsehen

tenHaaft
Innovative Mobile Technology





DIGITAL RV INSTALLS EVERYTHING WE SELL

We offer the complete package from sales through to installation, everything is backed up with full warranty & service.

Pop in for a nice coffee and a chat about your requirements.

Easy parking and access, complete with secure yard.

- ✓ Solar & Batteries
- ✓ Inverters and power systems
- ✓ Battery management solutions
- ✓ Televisions, Streaming, WiFi and Data
- ✓ Rear vision camera systems
- ✓ Fault finding and technical services
- ✓ Electrics and Electronics

Showroom conveniently located
43 Canada Cres
Hornby



High Definition Reversing Camera System

Unit only \$890

High quality, high definition industrial class reversing camera system

Smart IR night vision, audio and a IP69K rated heated camera makes this one of the most versatile kits on the market.

5m, 10m, 15m, 20m camera cables available.

Also includes a completely automatic IR filter for true daytime colour and exceptional night vision.

Features

- NZ Based warranty
- Daytime brightness and auto dimming
- Cast alloy camera
- Demisting heater. IP69K rated.
- Wide 160° viewing angle
- 3 x AHD & CVBS camera inputs
- 100 duty cycle - can be left on 24/7
- Reverse grid & automatic triggering
- Day/night infra-red filter

Available Accessories

- Mirror Replacement Mount
- Trailer Coupler
- Dash Mount (included)
- Flush Mount Bezel (included)

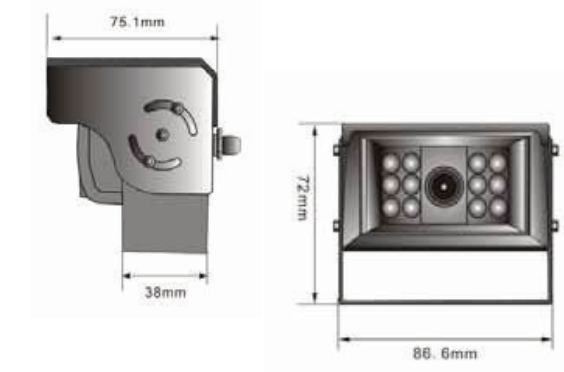

Specifications

Camera	
water / dust rating	IP69K with built in Heater
Resolution	720P
Audio	Yes
Night Vision	5m (smart IR)
Monitor	
Resolution	1024 x 600
Brightness	500cd/m2 and auto dimming
Camera Inputs	3 x AHD,CVBS auto selecting
System Input Voltage	10V-36V

 **From \$1350**

Installed

5" or 7" Vision S Wireless Camera System

7" Unit Only \$950
5" Unit Only \$900

The Furrion Vision S Camera System is designed to assist the driver by providing a clear and wide image of the area behind the vehicle whenever the vehicle is shifted into reverse.

We have tested many many Wireless cameras and this is the only one we would recommend if you cannot use a fully wired system

Great for Boats, Caravans where running wires is difficult or not possible

Also good if you use different towing vehicles



7" MONITOR



REAR CAMERA



SIDE CAMERA OPTIONAL

MONITOR & ACCESSORIES

- 2.4GHZ DIGITAL WIRELESS
- TOUCH SCREEN
- ANTI-GLARE
- REAR ASSIST MARKER LINES
- SECURITY CAMERA AUTO-WAKE
- DISPLAY UP TO 4 CAMERAS*
- AUDIO
- WINDSHIELD MOUNT
- INTERIOR TABLE STAND
- INTERIOR WALL MOUNT (sold separately)

Side marker cameras available - Call for pricing

REAR CAMERA



















- CMOS 120° VIEW ANGLE
- INFRARED NIGHT VISION
- CAMERA RESOLUTION 720x480
- INTELLIGENT IR CUT FILTER
- MOTION DETECT
- WATERPROOF IP65

 **From \$1150 Installed**



















Our install packages are the best way to purchase, they are fully installed including cables, connectors, sealants & labour If you choose multiple packages then discounts may apply, they also include full operational training.

Full warranty on parts and labour a great way to price you solutions, or ask us to tailor a custom package for you.

<p>DRVCRANK</p> 	<p>NZ SAT Windup Satellite Dish - Fully Installed</p> <p>Full Windup NZSAT Satellite Dish Installation Betaflex Cable Covering Ezifix Anchors Full Standard Install Customer Education Connection to 1 TV Elevation Chart GPS System for quick alignment Warning Alarm if you drive away with dish up.</p>	<p>Installed \$1850.00</p> 
<p>OYSTERNZ</p> 	<p>Fully Installed Oyster Automatic Dish</p> <p>Fully automatic Satellite dish from the experts at ten-Haaft German engineering to make an extremely reliable satellite dish system, with APP control for Satellite updates. High quality materials, Rotary head technology, LEM - Last elevation memory for faster scanning , Auto retraction and separate digital display for easy use. Now available in dark colour and specially designed for New Zealand operation 175mm when retracted.</p>	<p>Installed \$4100.00</p>      
<p>SATMAN 1</p> 	<p>TechniSat Portable Satellite Dish Kit</p> <p>SATMAN is a new portable dish from TechniSat. The unique square 45cm dish performs like a 60cm dish extremely high performance from small form dish. Our new portable version is on our heavy duty TRI base With 10M cable and 10750LNB</p>	<p>\$380.00</p> <p>Yellow Smiley version - SATMAN2</p>  
<p>TPD54</p> 	<p>Triax 54cm Portable Dish including cable and instructions</p> <p>Top of the line Triax Portable Dish Heavy duty triangular base - Withstands wind. Adjustable legs for easy levelling and easy align elevation system The reception quality of this dish is outstanding. 10M of Premium RG6 solid copper cable. Quality Triax 10750 LNB.</p>	<p>\$380.00</p> 
<p>SATMAN 3</p> 	<p>TechniSat Portable Satellite Dish Kit</p> <p>SATMAN is a new portable dish from TechniSat. The unique square 45cm dish performs like a 60cm dish extremely high performance from small form dish. Our new portable version is on the TechniSat Tripod Mount With 10M premium RG6 solid copper cable and 10750LNB</p>  <p>UPGRADE YOUR SATMAN DISH KIT+ \$70.00 Add a hard-wearing and water-repellent bag for easy transport of the TechniSat complete camping set for the SATMAN, aluminum tripod and accessories.</p>	<p>\$380.00</p> <p>Yellow Smiley version - SATMAN4</p>  <p>UPGRADE YOUR SATMAN DISH KIT +\$30 Upgrade your Satman dish kit to have a Sat Finder LNB This new LNB has built in Satellite signal bars - We just need to set you STB or TV to work with this amazing Universal LNB</p>  



<p>DRV195W</p> 	<p>195W / 205W Solar Panel & Controller Fully Installed</p> <p>1 PV 195W or 205W Mono-crystalline Solar Panel Fuse and Holder System 1 Victron 30 amp MPPT Solar Controller 4 x Terminals 1 Solar Plug and Socket Set Flexi Conduit 1 Solar Bracket Kit 1 x Solar Bracket Twin core Solar Cable Ezi Fix Pipe Clips.</p> <p>Panel sizes chosen based on spacing requirements</p>  <p>Includes bluetooth controller</p>	<p>\$1750.00</p> 
<p>DRV325W</p> 	<p>325W Solar Panel & Controller Fully Installed</p> <p>1 PV 325W Mono-crystalline Solar Panel Fuse and Holder System 1 Victron 30 amp MPPT Solar Controller 4 x Terminals 1 Solar Plug and Socket Set Flexi Conduit 1 Solar Bracket Kit 1 x Solar Bracket Twin core Solar Cable</p>  <p>Includes bluetooth controller</p>	<p>\$1850.00</p> 
<p>DRV390W</p> 	<p>2 x 195W / 2 x 205w Solar Panels & Controller Fully Installed</p> <p>2 PV 195W or 2 PV205 Mono-crystalline Solar Panel Fuse and Holder System 1 Victron 30 amp MPPT Solar Controller 4 x Terminals 2 Solar Plug and Socket Set Flexi Conduit 2 Solar Bracket Kit 4 x Solar Brackets Twin core Solar Cable Ezi Fix Pipe Clips.</p> <p>Panel sizes chosen based on spacing requirements</p>  <p>Includes bluetooth controller</p>	<p>\$2050.00</p> 
<p>DRV650W</p> 	<p>2 x 325W Solar Panels & Controller Fully Installed</p> <p>2 PV 325W Mono-crystalline Solar Panel Fuse and Holder System 1 Victron 50 amp MPPT Solar Controller 4 x Terminals 2 Solar Plug and Socket Set Flexi Conduit 2 Solar Bracket Kits 2 x Solar Brackets Twin core Solar Cable Ezi Fix Pipe Clips.</p>  <p>Includes bluetooth controller</p>	<p>\$2200.00</p> 
<p>DRV780W</p> 	<p>4 x 195W / 4 x 205W Solar Panels & Controller Fully Installed</p> <p>4 PV 195W or 4 x 205W Mono-crystalline Solar Panel + Fuse and Holder System 1 Victron 50 amp MPPT Solar Controller 4 x Terminals 4 Solar Plug and Socket Set Flexi Conduit 4 Solar Bracket Kits 2 x Solar Brackets Twin core Solar Cable Ezi Fix Pipe Clips.</p> <p>Panel sizes chosen based on spacing requirements</p>  <p>Includes bluetooth controller</p>	<p>\$2650.00</p> 
<p>DRVTOPUP</p> 	<p>30W-60W Solar Panel & Controller for Start Battery - Installed</p> <p>1 PV 30W / 60W Mini Panel 1 Victron 10 amp Solar Controller 4 x Terminals 1 Solar Plug and Socket Set Flexi Conduit 1 Solar Bracket Kit 1 x Solar Brackets Twin core Solar Cable Ezi Fix Pipe Clips.</p> <p>30w / 60W panel connected to your start battery just to keep everything topped up.</p> <p>Remarks: Upgrade to Bluetooth available for \$60</p>	<p>\$750-\$800</p> 





RV-12-100

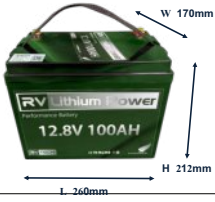

12V 100AH Lithium Iron Phosphate Battery With BMS-BT

Nominal Voltage 12.8V
 Nominal Capacity 100 Ah
 Energy 1280Wh
 Cycle Life >5000 @ 0.5C 50%
 DOD Efficiency 97-99%
 Charge Voltage 14.6 +- 0.2V



\$799.00

260x212x170mm



RV-12-120

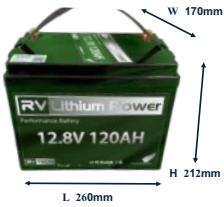

12V 120AH Lithium Iron Phosphate Battery With BMS-BT

Nominal Voltage 12.8V
 Nominal Capacity 120Ah
 Energy 1536Wh
 Cycle Life >6000 @ 50% DOD
 Efficiency 97-99%
 Charge Voltage 14.6 +- 0.2V



\$899.00

260x212x170mm



LI-12-150BMS



12V 150AH Lithium Iron Phosphate Battery With BMS-BT

Nominal Voltage 12.8V
 Nominal Capacity 150 Ah
 Energy 1920Wh
 Cycle Life >5000 @ 0.5C 50%
 DOD Efficiency 97-99%
 Charge Voltage 14.6 +- 0.2V

\$900.00

490x173x240
 Limited Stock
 Old Model
 First in best dressed.



RV-12-150

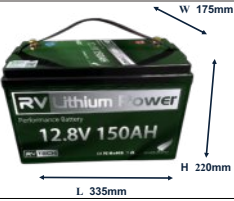

12V 150AH Lithium Iron Phosphate Battery With BMS-BT

Nominal Voltage 12.8V
 Nominal Capacity 200 Ah
 Energy 1920Wh
 Cycle Life >6000 @ 50% DOD
 Efficiency 97-99%
 Charge Voltage 14.6 +- 0.2V



\$1299.00

335x220x175mm



RV-12-200

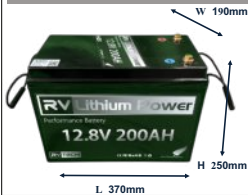

12V 200AH Lithium Iron Phosphate Battery With BMS-BT

Nominal Voltage 12.8V
 Nominal Capacity 200 Ah
 Energy 2568Wh
 Cycle Life >6000 @ 50% DOD
 Efficiency 97-99%
 Charge Voltage 14.6 +- 0.2V



\$1699.00

370x250x190mm



RV-12-300

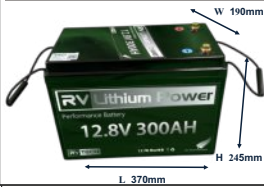

12V 300AH Lithium Iron Phosphate Battery with BMS-BT

Nominal Voltage 12.8V
 Nominal Capacity 300 Ah
 Energy 3840Wh
 Cycle Life >6000 @ 50% DOD
 Efficiency 97-99%
 Charge Voltage 14.6 +- 0.2V



\$2900.00

370x250x190mm



LI-51-100







51V 100AH 5U rack mount lithium-iron battery system

Built in BMS , and BMS data Bus compatible with Victron BMS
 Designed for scalability , network up to 64 Batterys in one
 complete system =**307KWH total**

\$3700.00







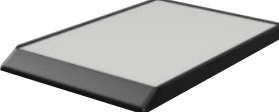

SHU050150050	SMARTSHUNT 500A/50MV Fully Installed	\$400.00
	<p>The SmartShunt is an all in one battery monitor, only without a display. Your phone acts as the display. The SmartShunt connects via Bluetooth to the VictronConnect App on your phone (or tablet) and you can conveniently read out all monitored battery parameters, like state of charge, time to go, historical information and much more. In addition, the SmartShunt can be connected and be read by a GX device. Connection to the GX device is made via a VE.Direct cable.</p>	

PIN1250	PHOENIX INVERTER 12/500 230V Fully Installed	From \$650.00
	<p>Victron Energy Phoenix Inverter 12/500 with VE.Direct communication port and 500VA pure sine wave output.</p> <p>500w will charge E bikes, Laptops, Cell Phones, CPAP Machines, and much more.</p> <p>Installed with remote switch</p>	

PMP122160000	MULTIPLUS 12/1600/70-16 230VAC INVERTER/CHARGER	From \$2600.00
	<p>The 500VA - 1200VA Multis are a powerful true sine wave inverter, a sophisticated battery charger that features adaptive charge technology and a high-speed AC transfer switch in a single compact enclosure. - Includes RCBO circuit protection</p> <p>* price is dependant battery size & capability's and switch board work required</p> <p>Installed to existing Power Outlets, includes new Electrical Warrant and electrical certificate of compliance</p>	

STARMNT2/3	Starlink Roof Mount Installation	From \$400 Installed
 	<p>Starlink is a Satellite internet connection , that will provide you with high speed data and wifi anywhere in New Zealand, Starlink doesnt provide Satellite TV , you still need a TV satellite dish for Freeview & Sky But it does give you great data for your Facebook, Trademe, Netflix and all internet services. Come and see us to see how we can help you have data everywhere.</p> <p>Get your existing Starlink Satellite Antenna flat mounted on the roof of your Motorhome , Caravan or RV.</p> <p>Digital RV have all the kits to flat mount your Starlink antenna and have it cabled permanently on the roof.</p> <p>Suitable options for all version including Gen3 V4 and Minis</p>	

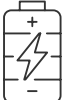



 Home Energy Storage	 Photovoltaic System	 Grid Energy Storage
 Energy Storage	 Lithium-Ion Battery	 Intelligent Software







Scan Me for APP







Our install packages are the best way to purchase, they are fully installed including cables, connectors, sealants & labour If you choose multiple packages then discounts may apply, they also include full operational training.

Full warranty on parts and labour a great way to price you solutions, or ask us to tailor a custom package for you.

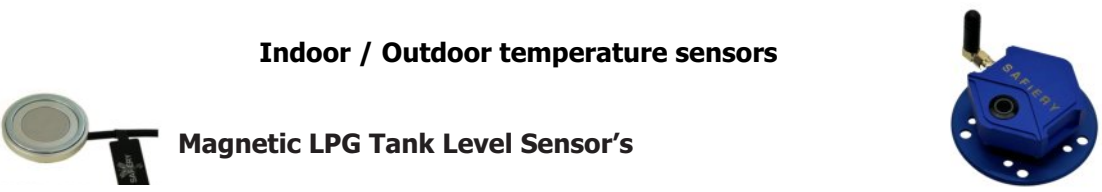
<p>VSMART</p> <p>1</p> 	<p>Victron Smart Touch Screen System - Start Package</p> <p>From \$800 Brand: Victron Energy</p> <p>Cerbo GX controller Choice of controllers and Touch displays Data Cables to your existing Victron modules- Works with Smart Shunts, Solar Chargers, Inverters and DC:DC Chargers.</p> <p>This GX-device provides monitoring and operates as the communication centre of your installation- Allows WiFi remote monitoring , Cloud logging of your usage and charging Share your information with friends and family, check your status from your phone - anywhere. touch screens and tank monitoring solutions Available add-ons, for data include 4G - 5 year IoT Connection kit</p> <p>We can build your Smart System</p>	
---	---	---

<p>VTANK</p> <p>2</p> 	<p>Tank & Temperature sensor add on's to VSMART</p> <p>Add Radar and Fixed Tank Sensors to your system Fresh - Grey - Black and Gas</p> <p>battery-operated radar tank level sensor's</p> <p>Indoor / Outdoor temperature sensors</p> <p>Magnetic LPG Tank Level Sensor's</p>	
---	---	---

<p>GLINK</p> 	<p>Global Link Incl 5 Years Activated Simcard</p> <p>Global connectivity with 4G LTE-M Your purchase includes 5 years of connectivity, so there is no need to worry about purchasing a separate data bundle and SIM-card</p> <p>Connect to your Victron Cerbo GX to get remote monitoring using 4G</p>	
--	---	--



Plug & Play WiFi for Everyone's Everything

Portable WiFi for your home, motorhome, and caravan

1. Purchase your modem through Digital RV
2. Choose your data package + Cost of Modem

NZMCA - Package Deal 1: \$49.49 Per Month
60GB FULL SPEED DATA.
followed by endless data at reduced speed with a maximum of 1.2 Mbps.

NZMCA - Package Deal 3: \$99.99 Per Month
UNLIMITED GB FULL SPEED DATA.
A plan with no data restrictions

You can put the connection on hold and only pay for the months you require. We'll just need 5 working days' notice when you wish to put it on hold (after one-month minimum activation).

NZMCA - Package Deal 2: \$69.69 Per Month
300GB FULL SPEED DATA.
followed by endless data at reduced speed with a maximum of 1.2 Mbps.

Get an external antenna installed for extra reception and better speeds
From \$200

RVTECH

12V Smart TVs

24S-LCD 27S-LCD



24" With Stand 542 x 350 x 110 mm

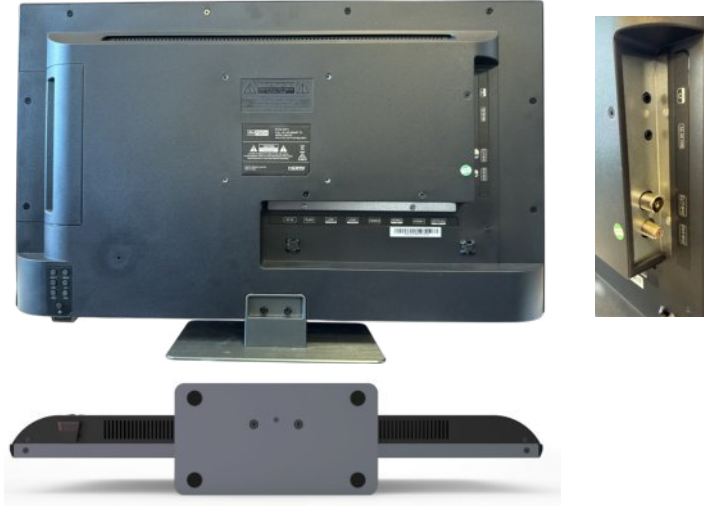

24" & 27" LCD 12V Smart TV

Introducing our 24" and 27" RVTECH smart TV's designed for the New Zealand RV market. Featuring the fully licensed LG webOS operating system. Now you can watch all your favorite freeview channels and have full use of your favorite streaming apps including Apple TV and supporting AirPlay. With its built in Wifi and Network port you can connect to the Internet for your latest movies and shows. Supporting Bluetooth you can pair the TV with wireless headphones or speakers for premium sound. Supplied with a 2 year warranty and local support. TV has never looked better.

Key features:

- Slim Body 42-43mm
- 1920 x 1080 Resolution
- Brightness: 200cd/m²
- Contrast 3000/1
- Visible screen area 47.664 x 26.811 cm
- Viewing angle:H/V:178 °/178°,
- Tuners DVBS/S2 (Satellite) & DVBT/T2 (Terrestrial)
- 2 x USB A sockets
- 3 x HDMI Inputs - (HDMI 2 with ARC)
- 1 x Optical Audio Out (for sound bar)
- 1 x Earphone Jack
- Net Weight 2.89kg
- Vesa mounting standard 100x100
- Bluetooth 5.0
- On screen user guide
- Internet based software updates.



Fully licensed webOS , HDMI & Dolby

OneTouch NETFLIX & PRIME Video buttons on remote

Download free APPS for:
You Tube - TVNZ+ Three Now - Disney -Sky Sport Now - Neon - Apple TV and many more

- Supplied with TV Stand
- Remote Control with batteries
- AC/DC Power Adapter
- 12VDC Cig Power Lead
- Quick start guide

24" RRP \$750.00
27" RRP \$850.00



Digital RV

24S-LCD



Scan Me

27S-LCD



Scan Me

27S-LCD 617 x 368 x 43 mm (W/H/D)
24S-LCD 542 x 318 x 42 mm (W/H/D)





240133

MegaSat 22" RV12V Smart TV with Satellite Tuner and DVD

\$790



The Royal Line 22 Premium has a 22-inch screen diagonal and offers a Full HD resolution of 1920 x 1080 pixels. For particularly high image quality, only Pixel Class 1 LED panels are used. its is equipped with the user-friendly webOS operating system, offering a particularly clear and responsive interface. All important functions, apps, and settings are intuitively accessible – for a comfortable and modern TV experience.

492 x 290 x 47 mm (W/H/D)
2.6KG Stand Optional.
15 watts - 1.2A
Standby < 0.5w

21.5 inch (54.6 cm) screen size

DVD Player , Mouse remote

240134

MegaSat 24" Version - With DVD

\$949



23.8 inch (60.5 cm) screen size

542 x 318x 42 mm (W/H/D)
3.3 KG Stand Optional
15 watts -1.2A
Standby < 0.5w

All features of MegaSat TV's are the same as RV Tech + Mouse remote and DVD player. (No Stand included)

DVD Player , Mouse remote

240135

MegaSat 27" Version - With DVD

\$990



27 inch (69.5 cm) screen size

617 x 368 x 43 mm (W/H/D)
4.0 KG Stand Optional
21 watts -1.68A
Standby < 0.5w

DVD Player , Mouse remote

240137

MegaSat 32" Version With DVD

\$1130



32 inch (81 cm) screen size

722 x 420 x 45 mm (W/H/D)
5.7 KG Stand Optional
27 watts - 2.1A
Standby < 0.5w

DVD Player , Mouse remote

MEGASAT
Brillantes Fernsehen

0900155

Sound Bar I - USB Powered Sound Bar for TV's

\$138.00



This compact soundbar significantly improves TV sound in your motorhome, caravan, or camper. It's vibration-resistant, easy to install, and ideal for mobile use. It connects directly to the TV's headphone jack—perfect for movies, series, or music on the go. With an output power of up to 12 watts (RMS), the broadband stereo speakers deliver clear, pleasant sound. Power for the soundbar is provided by the TV's USB port.

Brand: MegaSat
400 x 60 x 65mm
410gms - Includes
Bracket & Cables

MEGASAT
Brillantes Fernsehen

0900155

Sound Bar V - SoundBar with Bluetooth - USB port and remote

\$210.00



The solid cabinet houses 30 watts (RMS) of power, distributed across two full-range speakers. The result: clear speech intelligibility, impressive spatiality, and powerful bass. The simple, compact design completes the high-quality overall impression. The connection to the TV is made either via a 3,5 mm audio jack or – if Bluetooth is available – wirelessly via radio. Thanks to Bluetooth® can that be done. soundbar V also connects easily to smartphones and tablets. As a high-quality speaker, it ensures lossless transmission and impressive sound – even on the go.

Brand: MegaSat
420 x 60 x 60mm
788gms - Includes
Bracket & Cables

MEGASAT
Brillantes Fernsehen



Limited Stock.



TechniSat Mobile 32" Portable TV - with WiFi and Battery

\$650.00

The name says it all: With the **TECHNIVISION HD32AW MOBILE**, everything revolves around maximum mobility and flexibility when watching television. This full HD Smart TV with a 32-inch/80 cm screen diagonal has a built-in battery that enables up to four hours of TV or streaming enjoyment without being connected to a power source. So the game on TV or your Netflix show can easily be moved to awning or beach

**Works with bluetooth speakers for extra sound experience
Mobile TV - With Battery:**

Watch in the awning , outside , by the Spa , anywhere

Built in NETFLIX & Prime Video

If you have wifi you have entertainment



Free carry bag.

Satellite Tuner for Freeview
YouTube, Netflix, Prime Video, Youtube Kids
USB Recording and playback
2 x HDMI inputs for Sky TV or DVD s
Wifi and Network Socket

MINIVX



RV Tech Mini VX Satellite Receiver - Sky Card - HDMI 12V

\$220.00

Mini VX Satellite Receiver
DVBS/S2 Full HD
12VDC Operation includes Cig Lead
HDMI Cable Supplied
Remote IR Bug Included & Remote Control
Sky Card Slot - Works with all Sky Cards.
Preloaded with Freeview and Sky Channels

Does not work with the new Sky decoder.

If you change to the new white Sky Box , you cannot use it in your RV



0000/9117



BLUSPEAKER MINI 2

\$80.00

Loudspeakers =Stereo speakers -Output performance =2 x 8 W
Frequency response =60 - 20000 Hz
Audio in/AUX in
Micro USB -microSD card -Bluetooth 4.0 - HSP , HFP , A2DP, AVRCP - NFC
Rechargeable battery =2000 mAh - Battery life =7 h -Battery Charge time =2.5 h
Incredible sound from such a small portable speaker. TechniSat German Quality

Brand: TechniSat
206 x 64 x 60mm

TechniSat

0000/9119



BLUSPEAKER TWS XL

\$120.00

Loudspeakers =Stereo speakers , Output performance =2 x 15 W
Frequency response =60 - 18000 Hz ,Audio in/AUX in
Bluetooth 4.2 - HSP , HFP , A2DP, AVRCP , NFC
True Wireless Stereo (TWS) when paired with another TWS XL
Rechargeable battery =2200 mAh ,Battery life =9 h ,Battery charge time =4.5h
Amazing sound - Quality Brand, You have to hear this to believe it :)
Pair two units for Full Wireless Stereo

Brand: TechniSat
270 x 150 x 80 mm

TechniSat

NOTES:



DIGITAL RV

digital products & services for the mobile market

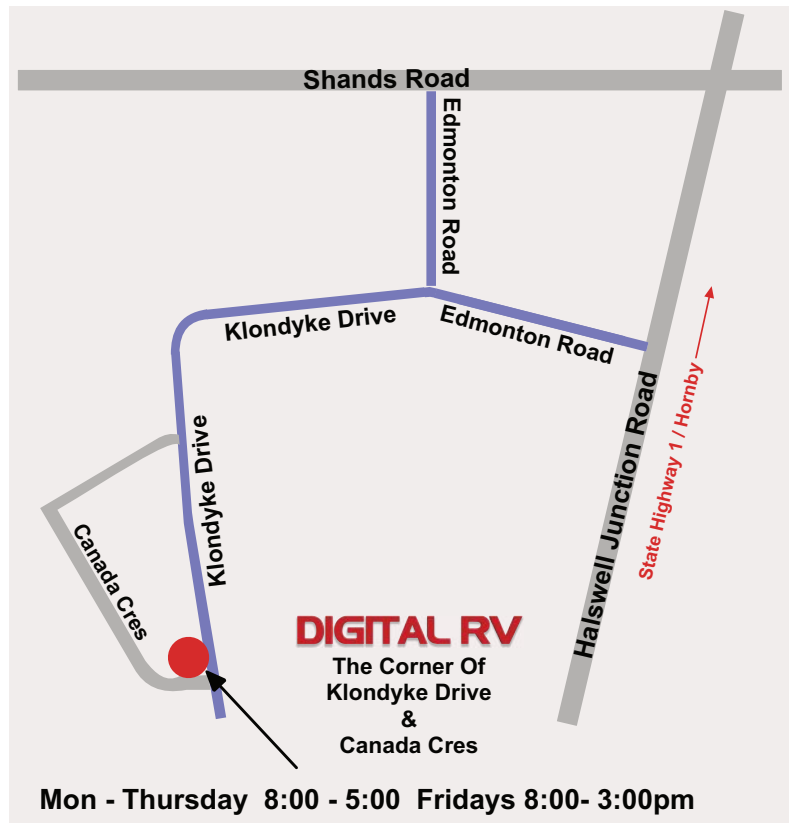

Purchase online
www.digitalstore.co.nz



or visit our
Showroom
Digital RV

43 Canada Crescent
Hornby South
Christchurch
03 344 5418

www.digitalrv.co.nz



Join our Facebook for latest deals

Digital RV

Digital RV are specialists in RV electrical and reception products
We service, Install, and provide support for everything we sell
From simple portable dishes to full electronic control systems
Come to Christchurch for exceptional un matched service
We can help you